

DATA SHEET

AS216-339, AS216-339LF: GaAs SPDT IC 7 W T/R Switch 300 kHz–2.5 GHz

Features

- High isolation (30 dB @ 0.9 GHz)
- Designed for mobile radio applications
- P₋₁ dB = 10 W @ 0.9 GHz, 25 °C
- High intercept point (IP3 63 dBm, @ 0.9 GHz)
- Available lead (Pb)-free and RoHS-compliant MSL-1 @ 260 °C per JEDEC J-STD-020

Description

The AS216-339 is a high-power IC FET SPDT switch in a plastic SOIC-8 exposed paddle package. This switch has been designed for use where extremely high linearity is required. It can be controlled with positive, negative or a combination of both voltages. Some standard implementations include antenna changeover, T/R and diversity switching over 2 W. This switch can be used in many analog and digital wireless communication systems including cellular, GSM and PCS applications.

NEW Skyworks offers lead (Pb)-free, RoHS (Restriction of Hazardous Substances)-compliant packaging.



Pin Out

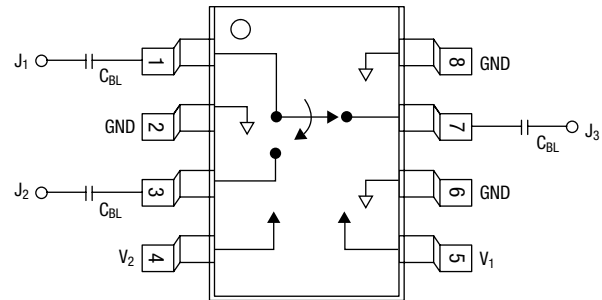

External DC blocking capacitors (C_{BL}) are required only if V_{HIGH} > 0.0 V.
C_{BL} = 100 pF for operation >500 MHz.

Electrical Specifications at 25 °C (0, -5 V)

Parameter ⁽¹⁾	Frequency	Min.	Typ.	Max.	Unit
Insertion loss ⁽²⁾	300 kHz–0.5 GHz		0.7	0.8	dB
	300 kHz–1.0 GHz		0.8	0.9	dB
	300 kHz–2.5 GHz		1.0	1.1	dB
Isolation	300 kHz–0.5 GHz	32	34		dB
	300 kHz–1.0 GHz	27	28		dB
	300 kHz–2.5 GHz	19	20		dB
VSWR ⁽³⁾	300 kHz–1.0 GHz		1.2:1	1.4:1	dB
	300 kHz–2.5 GHz		1.5:1	1.7:1	dB

1. All measurements made in a 50 Ω system, unless otherwise specified.

2. Insertion loss changes by 0.003 dB/°C.

3. Insertion loss state.

Operating Characteristics at 25 °C (0, -5 V)

Parameter	Condition	Frequency	Min.	Typ.	Max.	Unit
Switching characteristics						
Rise, fall	10/90% or 90/10% RF			6		ns
On, off	50% CTL to 90/10% RF			12		ns
Video feedthru	$T_{RISE} = 1 \text{ ns}$, BW = 500 MHz			30		mV
Input power for 1 dB compression	$V_{CTL} = 5 \text{ V}$ $V_{CTL} = 10 \text{ V}$	0.9 GHz		35		dBm
		0.9 GHz		40		dBm
Intermodulation intercept point	For two-tone input power 13 dBm IP3	0.9 GHz		63		dBm
Thermal resistance				45		°C/W
Control voltages	$V_{LOW} = -12 \text{ V} \leq V_{LOW} \leq 0 \text{ V}$, 500 μA max. $V_{HIGH} = 0 \text{ V} \leq V_{HIGH} \leq 12 \text{ V}$, 500 μA max. Differential = $5 \text{ V} \leq (V_{HIGH} - V_{LOW}) < 12 \text{ V}$					

Typical Performance Data (0, -5 V)

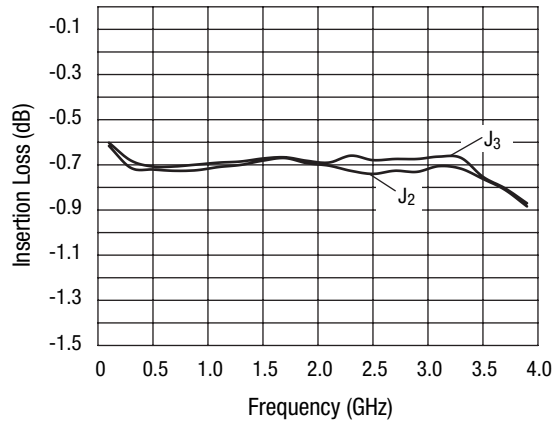

Insertion Loss vs. Frequency

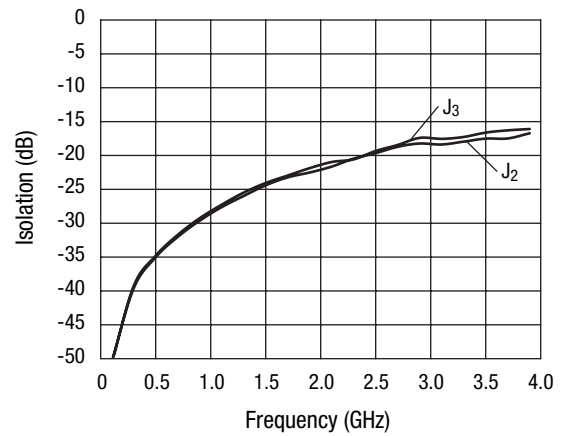

Typical Isolation vs. Frequency

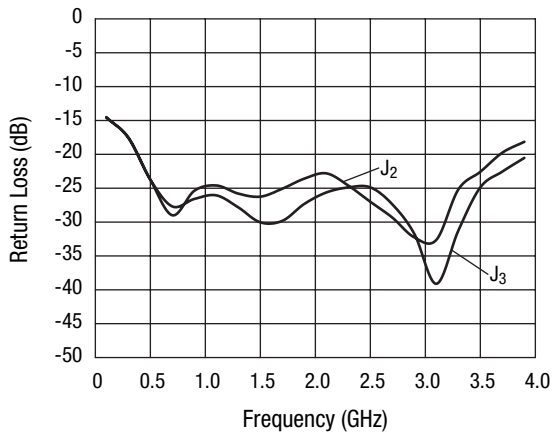

Typical Return Loss vs. Frequency

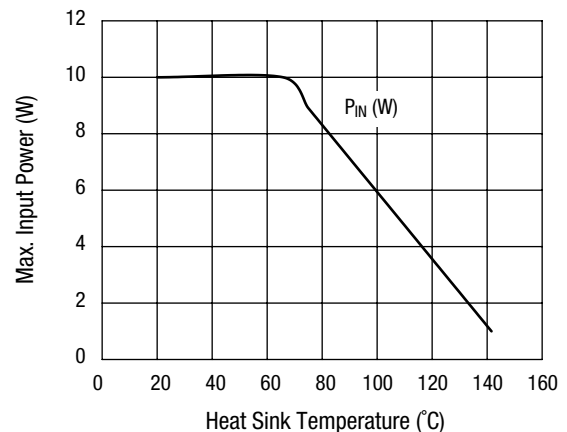

Temperature Derating Curve (0, +10)

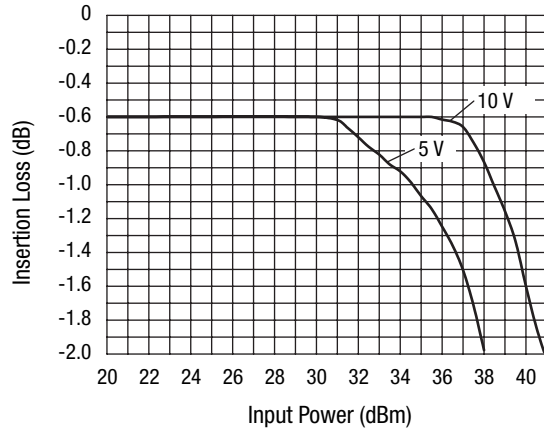

Compression at 900 MHz 25 °C

Truth Table

V ₁	V ₂	J ₁ -J ₂	J ₁ -J ₃
V _{LOW}	V _{HIGH}	Insertion loss	Isolation
V _{HIGH}	V _{LOW}	Isolation	Insertion loss

All other conditions not recommended.
 V_{LOW} = 0 to -12 V.
 V_{HIGH} = 0 to 12 V.
 Differential = 5 V ≤ (V_{HIGH} - V_{LOW}) < 12 V.
 Refer to Application Notes for further information on differential voltage operation.

Recommended Solder Reflow Profiles

Refer to the [“Recommended Solder Reflow Profile”](#) Application Note.

Tape and Reel Information

Refer to the [“Discrete Devices and IC Switch/Attenuators Tape and Reel Package Orientation”](#) Application Note.

Absolute Maximum Ratings

Characteristic	Value
RF input power	8 W > 0.9 GHz, 0, -12 V
Control voltage	(V _{HIGH} - V _{LOW}) < 12 V
Operating temperature	-40 °C to +85 °C
Storage temperature	-65 °C to +150 °C

Performance is guaranteed only under the conditions listed in the specifications table and is not guaranteed under the full range(s) described by the Absolute Maximum specifications. Exceeding any of the absolute maximum/minimum specifications may result in permanent damage to the device and will void the warranty.

CAUTION: Although this device is designed to be as robust as possible, ESD (Electrostatic Discharge) can damage this device. This device must be protected at all times from ESD. Static charges may easily produce potentials of several kilovolts on the human body or equipment, which can discharge without detection. Industry-standard ESD precautions must be employed at all times.

SOIC-8 Exposed Paddle

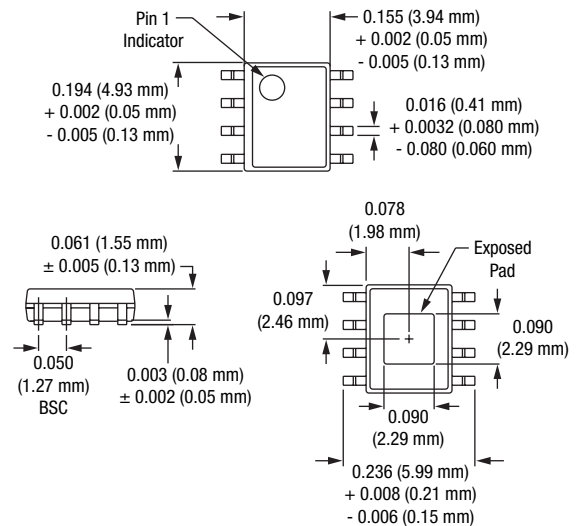

Copyright © 2002, 2003, 2004, 2005, 2006, Skyworks Solutions, Inc. All Rights Reserved.

Information in this document is provided in connection with Skyworks Solutions, Inc. ("Skyworks") products or services. These materials, including the information contained herein, are provided by Skyworks as a service to its customers and may be used for informational purposes only by the customer. Skyworks assumes no responsibility for errors or omissions in these materials or the information contained herein. Skyworks may change its documentation, products, services, specifications or product descriptions at any time, without notice. Skyworks makes no commitment to update the materials or information and shall have no responsibility whatsoever for conflicts, incompatibilities, or other difficulties arising from any future changes.

No license, whether express, implied, by estoppel or otherwise, is granted to any intellectual property rights by this document. Skyworks assumes no liability for any materials, products or information provided hereunder, including the sale, distribution, reproduction or use of Skyworks products, information or materials, except as may be provided in Skyworks Terms and Conditions of Sale.

THE MATERIALS, PRODUCTS AND INFORMATION ARE PROVIDED "AS IS" WITHOUT WARRANTY OF ANY KIND, WHETHER EXPRESS, IMPLIED, STATUTORY, OR OTHERWISE, INCLUDING FITNESS FOR A PARTICULAR PURPOSE OR USE, MERCHANTABILITY, PERFORMANCE, QUALITY OR NON-INFRINGEMENT OF ANY INTELLECTUAL PROPERTY RIGHT; ALL SUCH WARRANTIES ARE HEREBY EXPRESSLY DISCLAIMED. SKYWORKS DOES NOT WARRANT THE ACCURACY OR COMPLETENESS OF THE INFORMATION, TEXT, GRAPHICS OR OTHER ITEMS CONTAINED WITHIN THESE MATERIALS. SKYWORKS SHALL NOT BE LIABLE FOR ANY DAMAGES, INCLUDING BUT NOT LIMITED TO ANY SPECIAL, INDIRECT, INCIDENTAL, STATUTORY, OR CONSEQUENTIAL DAMAGES, INCLUDING WITHOUT LIMITATION, LOST REVENUES OR LOST PROFITS THAT MAY RESULT FROM THE USE OF THE MATERIALS OR INFORMATION, WHETHER OR NOT THE RECIPIENT OF MATERIALS HAS BEEN ADVISED OF THE POSSIBILITY OF SUCH DAMAGE.

Skyworks products are not intended for use in medical, lifesaving or life-sustaining applications, or other equipment in which the failure of the Skyworks products could lead to personal injury, death, physical or environmental damage. Skyworks customers using or selling Skyworks products for use in such applications do so at their own risk and agree to fully indemnify Skyworks for any damages resulting from such improper use or sale.

Customers are responsible for their products and applications using Skyworks products, which may deviate from published specifications as a result of design defects, errors, or operation of products outside of published parameters or design specifications. Customers should include design and operating safeguards to minimize these and other risks. Skyworks assumes no liability for applications assistance, customer product design, or damage to any equipment resulting from the use of Skyworks products outside of stated published specifications or parameters.

Skyworks, the Skyworks symbol, and "Breakthrough Simplicity" are trademarks or registered trademarks of Skyworks Solutions, Inc., in the United States and other countries. Third-party brands and names are for identification purposes only, and are the property of their respective owners. Additional information, including relevant terms and conditions, posted at www.skyworksinc.com, are incorporated by reference.